

ORIGINAL INSTRUCTIONS >EN

FEIDER

MACHINES



PETROL LAWN TRACTOR

FRT90EL

USER GUIDE

CAUTION: Read this manual before using this machine!

INTRODUCTION

Dear Customer,

Thank you for having chosen one of our products. We hope that you will get complete satisfaction from using your new machine and that it will fully meet all your expectations. This manual has been compiled in order that you may get to know your machine and to be able to use it safely and efficiently. Don't forget that it forms an integral part of the machine, so keep it handy so that it can be consulted at any time and pass it on to the purchaser if you resell the machine.

This new machine of yours has been designed and made in line with current regulations, and is safe and reliable if used for cutting and collecting grass according to the instructions given in this manual (**proper usage**). Using the machine in any other way or ignoring the instructions for safe usage, maintenance and repair is considered "**incorrect usage**" (☛5.1) which will invalidate the guarantee and the manufacturer will decline all responsibility, placing the blame with the user for any damage or injury to himself or others in such cases.

Since the product is continually being improved, you may find slight differences between your machine and the descriptions contained in this manual. Certain modifications can be made to the machine without prior warning and without the obligation to update the manual, although the essential safety and function characteristics will remain unaltered. In case of any doubts, do not hesitate to contact your Retailer. And now enjoy your work!

AFTER-SALES SERVICE

This manual gives all the necessary instructions for using the machine and the basic maintenance that may be carried out by the user.

For any information not contained here, contact your Local Retailer or a Licensed Service Centre.

If you wish, your Retailer will be pleased to offer maintenance programmed personalized to your needs. This will enable you to keep your new acquisition in peak performance, maintaining its value.

TABLE OF CONTENTS

1. SAFETY	4
2. IDENTIFICATION OF THE MACHINE AND COMPONENTS.....	9
3. UNPACKING AND ASSEMBLY	10
4. CONTROLS AND INSTRUMENTS	12
5. HOW TO USE THE MACHINE	14
6. MAINTENANCE	26
7. ENVIRONMENTAL PROTECTION	29
8. TROUBLESHOOTING.....	29
9. ACCESSORIES ON REQUEST	31
10. SPECIFICATIONS	32
11. DECLARATION OF CONFORMITY	33
12. WARRANTY	34
13. PRODUCT FAILURE	35
14. WARRANTY EXCLUSIONS	36

1. SAFETY

1.1 HOW TO READ THE MANUAL

This manual describes various versions of the machine, which mainly differ in:

- type of transmission: with either mechanical gear change or continuous speed converter.
- the inclusion of components or accessories which may not be available in some areas;
- special equipment fitted.

The symbol “” highlights all the differences in usage and is followed by the indication of the version that it refers to.

The symbol “” makes a reference to another part of the manual where further information or clarification can be found.

Some paragraphs in the manual containing information of particular importance for safety and operation are highlighted and signify the following:

NOTE

or

IMPORTANT

These give details or further information on what has already been said, and aim to prevent damage to the machine.

 **WARNING!**

Non-observance will result in the risk of injury to oneself or others.

 **DANGER!**

Non-observance will result in the risk of serious injury or death to oneself or others

NOTE

Whenever a reference is made to a position on the machine “front”, “back”, “left” or “right” side, this is determined by facing the direction of forward travel.

IMPORTANT

For all usage and maintenance operations on the engine or the battery which are not described in this manual, consult the relevant manuals which form an integral part of all the documentation supplied with the machine.

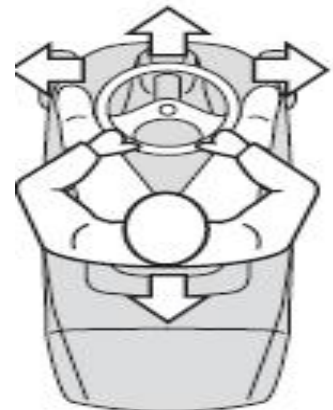

1.2 GENERAL SAFETY REGULATIONS



WARNING!

Read carefully before using the machine.

A) TRAINING

- 1) **Read the instructions carefully.** Be familiar with the controls and how to use the equipment properly.
- 2) Never let children or people unfamiliar with these instructions use the machine. Local regulations can restrict the age of the user.
- 3) **Never mow while people, especially children, or pets are nearby.**
- 4) Keep in mind that the operator or user is responsible for accidents or hazards occurring to other people or their property.
- 5) Do not carry passengers.
- 6) All drivers should seek and obtain professional and practical instruction. Such instruction should emphasize:
 - the need for care and concentration when working with ride on machines;
 - you cannot use the brake to regain control of a ride-on machine sliding down a slope.
The main reasons for loss of control are:
 - insufficient wheel grip;
 - over speeding;
 - inadequate braking;
 - the type of machine is unsuitable for its task;
 - unawareness of the effect of ground conditions, especially slopes;

B) PREPARATION

- 1) While mowing, always wear sturdy footwear and long trousers. Do not operate the equipment barefoot or wearing open sandals.
- 2) Thoroughly inspect the area where the equipment is to be used and remove all objects which can be ejected from the machine.
- 3) **DANGER! Petrol is highly flammable:**
 - store fuel in containers specifically designed for this purpose;
 - refuel outdoors only and do not smoke while refueling;
 - Add fuel before starting the engine. Never remove the cap of the fuel tank or add petrol while the engine is running or when the engine is hot;
 - If you spill petrol, do not start the engine and move the machine away from the area of spillage. Do not create any source of ignition until the petrol vapors have evaporated;
 - put back and tighten all fuel tank and container caps securely.
- 4) Replace faulty silencers.
- 5) Before use, always visually inspect to see that the blade, blade bolts and cutter assembly are not worn or damaged. Replace the worn or damaged blade and bolts in sets to preserve the balance.

C) OPERATION

- 1) Do not start the engine in a confined space where dangerous carbon monoxide fumes can collect.
- 2) Mow only in daylight or good artificial light.
- 3) Before starting the engine, disengage the blades and shift into neutral.
- 4) **Do not use on slopes of more than 10° (17%).**
- 5) **Remember there is no such thing as a “safe” slope.**
Travelling on grass slopes requires particular care. To guard against overturning:
 - do not stop or start suddenly when going up or downhill;
 - engage the drive slowly and always keep the machine in gear, especially when travelling downhill;
 - machine speeds should be kept low on slopes and during tight turns;
 - stay alert for humps and hollows and other hidden hazards;
 - **never mow across the face of the slope.**
- 6) Stop the blade from rotating before crossing surfaces other than grass.
- 7) **Never use the machine with damaged guards, or without the safety protective devices in place.**
- 8) **Do not change the engine governor settings or over speed the engine.** Operating the engine at excessive speed can increase the risk of personal injury.
- 9) Before leaving the driving seat:
 - Lift emergency stop switch and lower chassis position
 - go into neutral and apply the parking brake;
 - stop the engine and remove the ignition key (in the electric start models).
- 10) Lift the emergency stop switch, turn off the engine and remove the start key
 - before clearing blockages or unclogging chutes;
 - before cleaning, checking or working on the machine;
 - after striking a foreign object. Inspect the machine for any damage and make repairs before restarting and operating the equipment;
 - If the machine starts to vibrate abnormally (inspect it immediately).
- 11) Disengage the power when transporting or whenever it is not in use.
- 12) **Stop the engine and disengage the power:**
 - before refueling;
 - before removing the grass-catcher.
- 13) Reduce the throttle setting before stopping the engine.

D) MAINTENANCE AND STORAGE

- 1) Keep all nuts, bolts and screws tight to be sure the equipment is in safe working condition.
- 2) Never store the equipment with petrol in the tank inside a building where fumes may reach an open flame or spark.
- 3) Allow the engine to cool before storing in any enclosure.
- 4) To reduce fire hazards, keep the engine, silencer, battery compartment and petrol storage area free of grass, leaves, or excessive grease.

- 5) Check the grass-catcher frequently for wear or deterioration.
 - 6) Replace worn or damaged parts for safety purposes.
 - 7) If the fuel tank has to be drained, this should be done outdoors.
 - 8) When the machine is to be stored or left unattended, lower the cutting deck.
- Improper maintenance can reduce life of the tool and create accident and damages.
Always bring maintenance.

the lawnmower safety systems or features shall not be tampered with or disabled;
the operator should not alter or tamper with any sealed adjustments for the engine speed control;

Warning: there is a danger of moving blade assemblies during adjustment;

Use the tool only for the intended use as described in manual. Misuse will create accidents and damages.

Warning: do not use the tool while being tired, ill or under influence of alcohol or other drugs.

The lawnmower shall not be operated without either the entire grass catcher or self-closing discharge opening guard in place”

Prolonged use will expose the user to vibration which can affect health. Limit the duration of operation and wear gloves.

Warning: Do not use of the lawnmower when there is a risk for lightning;

Residual risks

Even if you use this product in compliance with all safety requirements, the potential risks of injury and damage remain. The following hazards may arise in the structure and design of this product:

Always be vigilant when using this product, so you can recognize and manage the risks rather.

There are adverse health consequences resulting from the emission of vibration if the product is used for long periods of time or not properly managed and properly maintained. There are risks of injury and property damage due to attachments or broken the sudden impact of hidden objects when using cutting.

Risk of injury to persons and property caused by flying objects.

Prolonged use of this product exposes the operator to vibrations and can produce so-called "white finger" disease. To reduce the risk, wear gloves and keep your hands warm.

If any of the symptoms of "white finger syndrome" occur, seek immediate medical attention.

Symptoms of "white finger" include numbness, loss of sensitivity, tingling, tingling, and pain, loss of strength, color changes or skin condition. These symptoms usually appear on the fingers, hands or wrists. Risk increases at low temperatures.

There is a risk of loss hearing in case of prolonged use and when a hearing protection is not worn. Wear hearing protection.

Intended use

This model of thermal mower is designed for natural grass mowing. Any other use is prohibited.

It is suitable only for private use in a garden or plot. Lawnmowers designed for private

plots or gardens are those used for the maintenance of grassy areas and private lawns and should not be used in public areas, parks, sports, agricultural or forest areas.

1.3 SAFETY LABELS

Your machine must be used with care. Therefore, labels have been placed on the machine to remind you pictorially of the main precautions to take during use. These labels are to be considered an integral part of the machine. If a label should fall off or become illegible, contact your Retailer to replace it. Their meaning is explained below.



Warning: Read the Operator's Manual before operating this machine.



Warning (in the manual start models): disconnect the spark plug cap and read the instructions before carrying out any maintenance or repairs.



Warning (in the electric start models): remove the key and read the instructions before carrying out any maintenance or repairs.



Danger! Ejected objects: Keep bystanders away.



Danger! Dismemberment: Make sure that children stay clear of the machine all the time when engine is running.



Danger! Ejected objects: Do not operate without the grass catcher in place.



Danger! Machine rollover: Do not use this machine on slopes greater than 10°



Danger of cutting yourself. Blade in movement. Do not put hands or feet near or under the opening of the cutting plate.



Danger! Away from the danger of combustible substances



Danger! Do not near the operational machine



WARNING! Do not put hands or feet near rotating parts or under the cutting deck. Contact with the blade(s) can amputate hands and feet.



Danger ! Electrical shock !



The surface is very hot and not touching.



Guaranteed sound power level.



Risk of fire

2. IDENTIFICATION OF THE MACHINE AND COMPONENTS

2.1 IDENTIFICATION OF THE MACHINE

The identification label located under the seat has the essential data of each machine.

2.2 NAME AND ADDRESS OF MANUFACTURER

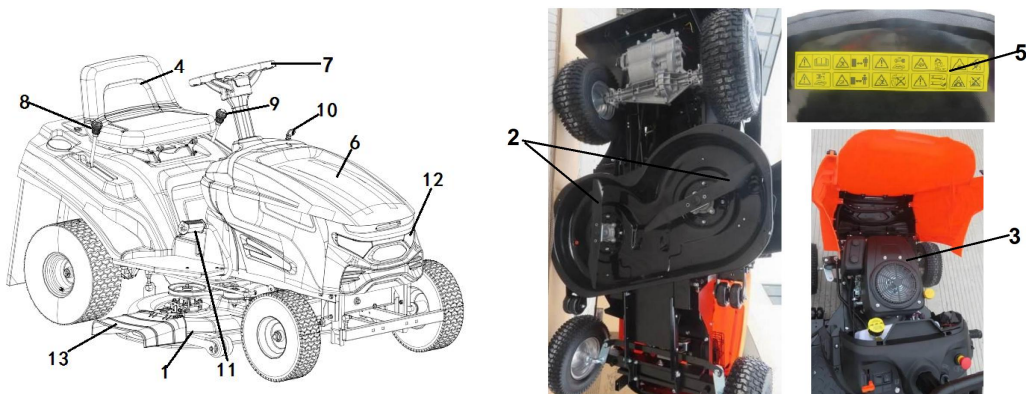

The machine with side discharge is composed of a series of main component

1. **Cutting deck:** this is the guard enclosing the rotating blade towards the collector channel.
2. **Blade:** This is for cutting grass, with wings at the end for transporting the cut grass to the hay bin.
3. **Engine:** this moves the blade and drives the wheels. Its specifications and regulations for use are described in a specific manual.

4. **Driver seat:** this is where the machine operator sits. It has a sensor which detects the presence of the operator and acts as a safety device.
5. **Labels for regulations and safety:** give reminders on the main provisions for working safely, each of which is explained in chapter 1.
6. **Engine cover:** for access to the engine
7. **Steering wheel:** Adjust the direction of movement
8. **Speed adjustment gear lever:** adjust the gear of the gearbox
9. **Mowing height gear lever:** adjust the height of the mowing knife tray
- 10 **Speed adjusting rod:** adjust the speed of the engine.
11. **Brake pedal:** Machine brake.
12. **Headlights:** Provide lighting
13. **Side discharge:** as well as collecting the grass cuttings, this is also a safety element in that it stops any objects drawn up by the blade from being thrown outside of the machine.
14. **Batteries (*only in the electric start models*):** provides the energy for starting the engine. Its specifications and regulations for use are described in a specific manual.

3. UNPACKING AND ASSEMBLY

For storage and transport purposes, some components of the machine are not installed in the factory and have to be assembled after unpacking. Follow the instructions below.

IMPORTANT

The machine is supplied without engine oil or fuel. Before starting the engine, fill with oil and fuel following the instructions given in the engine manual.

WARNING!

Unpacking and completing the assembly should be done on a flat and stable surface, with enough space for machine handling and its packaging, always making use of suitable equipment.

3.1 UNPACKING

When unpacking the machine, take care to gather all the individual parts, fittings and documentation.

NOTE

To avoid damaging the cutting deck when getting the machine down from the pallet, take it to the maximum height and be very careful.

The supply includes:

- the battery;
- bolts and screws, necessary for completing the assembly;
- a syringe for draining the engine oil. (on request)

Disposal of the packaging should be done in accordance with the local regulations in force.

3.2 FITTING THE STEERING WHEEL

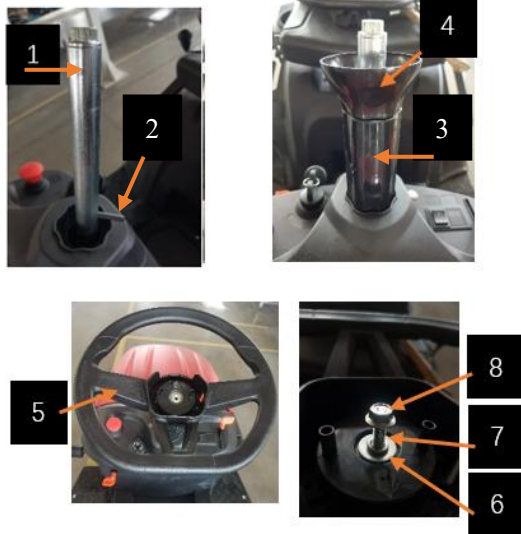

Place the machine on a flat surface and straighten the front wheels.

- Install steering wheel shaft (1)
- Tap in elastic cylindrical pin (2),
- Install casing (3), casing base (4),
- Align steering wheel (5) on steering wheel shaft
- Place flat washer (6) and spring washer (7) and tighten bolt (8).

3.3 FITTING THE SEAT

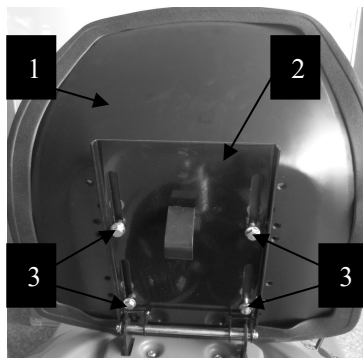

Fit the seat (1) onto the plate (2) using the screws (3)

3.4 CONNECTING THE BATTERY



Open the seat and then connect the both terminal.

IMPORTANT

Never start the engine until the battery is fully charged!

⚠ WARNING!

Follow the battery manufacturer's instructions regarding safe handling and disposal.

4. CONTROLS AND INSTRUMENTS



4.1 STEERING WHEEL

Turns the front wheels.

4.2 CLUTCH / BRAKE PEDAL



It has a double function: during the first part of its travel it acts as a clutch, engaging and disengaging drive to the wheels, and in the second part it works the brake.

IMPORTANT

Do not keep the pedal half way of clutch engagement or disengagement, as this can cause overheating and damage the transmission belt

NOTE

When the machine is in movement, keep your foot off the pedal. ▶

4.3 PARKING BRAKE LEVER

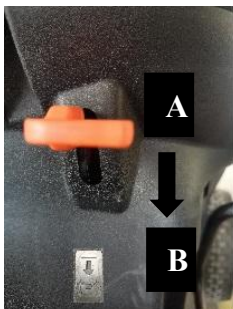

This lever stops the machine from moving when it has been parked. There are two positions:

⤴ «A» = Brake off

Ⓟ «B» = Brake engaged

– The brake is engaged by pressing the pedal (▶ 4.2) right down and moving the lever to position «B». When you take your foot off the pedal it will be blocked by the lever in the down position.

- To disengage the parking brake, press the pedal (➔4.2). The lever will return to position «A».

4.4 SPEED CHANGE LEVER

This lever has six positions for the four forward gears, the neutral position «N», and reverse «R». To change gear press the pedal (➔4.2) halfway down and move the lever as per the indications on the label.

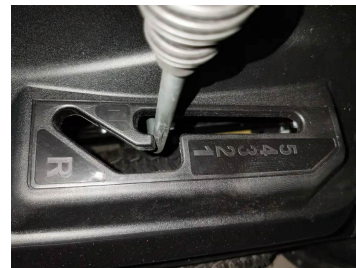

Reverse must be engaged when the machine has stopped.

4.5 CUTTING HEIGHT ADJUSTING LEVER



There are five positions for this lever, shown as «1» to «5» on the plate, which correspond to various cutting heights from 3.5 to 7.5 cm.

- To go from one position to another, move the lever sideways and put it back in one of the stop notches.

4.6 KEY IGNITION SWITCH



This key operated control has three positions:



- «O» everything is switched off;
- «—» activates all parts;
- «» engages the starter

On being released at the «START» position, the key will automatically return to «ON».

4.7 ABRUPT STOP SWITCH



This switch controls the pulling in and out of the electromagnetic clutch.

-  «A» = Blade engaged
-  «B» = Blade disengaged

A: When the emergency stop switch is lifted, the electromagnetic clutch is put ON. To make it powered ON, the key switch (4.6) must be in the ON position.
 "B": When the emergency stop switch is pressed, the electromagnetic clutch is disconnected and the blade stops rotating.

4.8 ACCELERATOR LEVER



Regulates the engine's speed. The positions are indicated on a plate showing the following symbols :



«CHOKE» (if fitted) = cold starting



«FAST» for maximum engine speed



«SLOW» for minimum engine speed

- The «CHOKE» position (if fitted) enriches the mixture so must only be used for the necessary time for cold starting.
- When moving from one area to another, put the lever in a position between «SLOW» and «FAST».
- When cutting, go to the «FAST» position.

5. HOW TO USE THE MACHINE

5.1 SAFETY RECOMMENDATIONS

DANGER!

The machine must only be used for the purpose for which it was designed (cutting and collection of grass).

Using the machine in any other way is considered "improper use" which will invalidate the warranty, relieve the manufacturer from all liabilities, and the user will consequently be liable for all and any damage or injury to himself or others.

Examples of improper use may include, but are not limited to:

- *transport people, children or animals on the machine or on a trailer;*
- *tow or push loads;*
- *use of the machine for moving over unstable, slippery, icy, stony, rough, marshy ground and puddles that do not allow for evaluation of the consistency of the ground;*
- *use of the machine for leaf or debris collection;*
- *use of the blades on surfaces other than grass*

DANGER!

Do not tamper with or remove the safety devices fitted to the machine. REMEMBER THAT THE USER IS ALWAYS RESPONSIBLE FOR DAMAGE AND INJURIES TO OTHERS. Before using the machine:

- *read the general safety regulations (1.2), paying particular attention to driving and cutting on slopes;*
- *carefully read the instructions for use, become familiar with the controls and on how to quickly stop the blade and engine.*

- *never put your hands or feet next to or beneath the rotating parts and always keep away from the discharge opening.*

Do not use the machine when in a precarious state of health or under the effect of medicines or other substances that can reduce your reflex actions and your ability to concentrate. It is the user's responsibility to assess the potential risk of the area where work is to be carried out, as well as to take all the necessary steps to ensure his own safety and that of others, particularly on slopes or rough, slippery and unstable ground. Do not leave the machine stopped on high grass with the engine running to avoid the risk of starting a fire. Always lower the speed when changing direction, especially on tight turns.



This machine must not be used on slopes greater than 10° (17%) (☛ 5.5).

IMPORTANT

All the references relating to the positions of controls are those described in chapter 4.

5.2 WHY THE SAFETY DEVICES CUT IN

The safety devices work in two ways:

- by preventing the engine from starting if all the safety requirements have not been met;
- by stopping the engine if even just one of the safety requirements is lacking.

a) The engine must only be started in the following conditions:

- the transmission is in “neutral”;
- the blade is not engaged;
- the operator is seated or the parking brake is engaged.

b) The engine stops when:

- the operator leaves his seat when the blade is engaged;
- the operator leaves his seat with a gear engaged;
- the grass-catcher is lifted without disengaging the blade;
- the blade is engaged without the grass-catcher in place;
- the parking brake is engaged without disengaging the blade;
- the speed change is activated (☛ 4.4) with the parking brake on.

5.3 PRELIMINARY OPERATIONS BEFORE STARTING WORK

These controls ensure that the work gives the best results and is done in maximum safety.

5.3.1 Seat adjustment

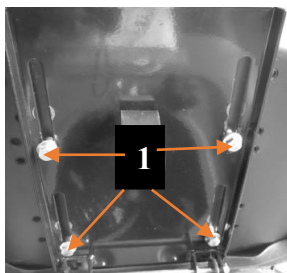

Adjust the seat by sliding it along the bracket slots.

1. Loosen the four screws (1);
2. once you have found the right position, securely tighten screws.

5.3.2 Tire pressure

Having the correct tire pressure is essential for ensuring that the cutting deck is perfectly horizontal and thus mows evenly.

1. Unscrew the valve caps;
2. Connect a compressed air line with a gauge to the valves and adjust the pressure to the indicated values.
3. Screw the valve caps back on.

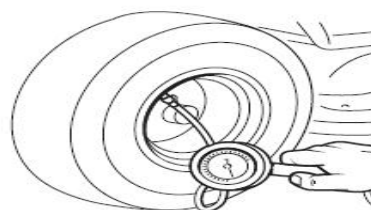

5.3.3 Filling with oil and fuel



Refueling should be carried out in an open or well-ventilated area with engine stopped. Always remember that petrol fumes are inflammable. DO NOT TAKE A NAKED FLAME TO THE TANK'S OPENING IN ORDERS TO SEE THE TANK'S CONTENTS AND DO NOT SMOKE WHEN REFUELLING.

NOTE

The type of oil and fuel to be used is given in the engine manual.

With the engine stopped, check its oil level.

1. to reach the plug (1), remove the engine cover (2) with the aid of a screwdriver
2. by closely following the methods described in the engine manual, make sure the oil level is between the MIN and MAX marks on the dipstick (3);
3. always refit the plug (1) and engine cover (2).

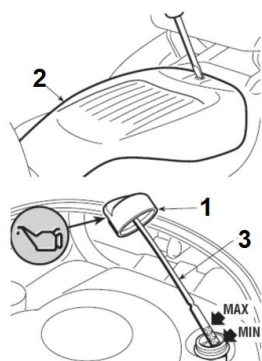

To refuel (to be done when the machine has stopped):

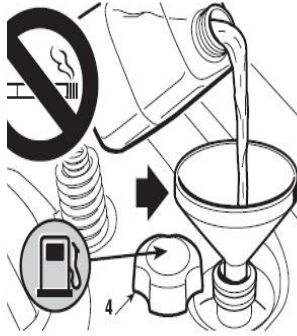

1. unscrew the plug (4) from the tank located behind the seat;
2. Fill the tank with fuel through a funnel, but it cannot be completely filled. The fuel tank volume is about 5 liters.
3. always refit the plug(4)

IMPORTANT

Do not drip petrol onto the plastic parts to avoid ruining them. In the event of accidental leaks, rinse immediately with water. The warranty does not cover for damage to plastic parts of the bodywork or the engine caused by petrol.

5.3.4 Checking machine safety and efficiency

1. Check that the safety devices function as described(☛5.2).
2. Check that the brake is in perfect working order.
3. Do not start mowing if the blade vibrates or if you are unsure whether they are sharp enough. Always remember that:
 - A badly sharpened blade pulls at the grass and causes the lawn to turn yellow.
 - A loose blade causes unwanted vibrations and can be dangerous.

⚠ WARNING!

Do not use the machine if you are unsure whether it is working safely or efficiently. If in doubt, contact your Dealer immediately to make the necessary checks and repairs

5.4 USING THE MACHINE

5.4.1 Starting the engine

⚠ DANGER!

all starting operations have to be effected in an open or well-ventilated area! ALWAYS REMEMBER THAT EXHAUST GASES ARE TOXIC!



To start the engine:

1. sit on the seat and press the emergency stop switch (☛4.7);
2. put the transmission into neutral («N») (☛ 4.4);
3. for cold starting, put the accelerator lever in the «CHOKE» position (if fitted) as shown on the label (☛ 4.8).

Alternatively, if the engine is still hot or without a choke, position the lever between «SLOW» and «FAST»;



Electric start

5. put in the key (☛ 4.6) and turn to «ON» to make electrical contact, then turn to «START» to start the engine;
6. release the key once the engine has started;

IMPORTANT

The choke (if fitted) must be closed as soon as possible. Using it when the engine is already warm can foul the spark plugs and cause the engine to run erratically.

NOTE

If you have difficulty starting, do not make several attempts to avoid flooding the engine or running down the battery (if present).

- Check that the conditions allowing the engine to start are met
- Turn the key (electric start) to «OFF». Wait for a few seconds and repeat the start operation. Should the malfunction persist, refer to chapter «8» of this manual and the engine manual.

5.4.2 Starting and moving without mowing

⚠ WARNING!

this machine has not been approved for use on public roads. It has to be used (as indicated by the Highway Code) in private areas closed to traffic.

NOTE

When moving the machine, the blade must be disengaged and the cutting deck put at its highest position.

To start the forward movement:

1. put the accelerator control between the «SLOW» and «FAST» positions;
2. push the pedal right down (☛4.2) and put the gear change lever in 1st gear (☛4.4a).
3. release the pedal gradually to begin the movement.

Reach the desired operating speed using the accelerator and gear lever. To change gear, the clutch must always be used by pushing the pedal (☛4.2).

⚠ WARNING!

The pedal must be released gradually as sudden engagement may cause tipping up and loss of control of the vehicle.

⚠ WARNING!

Do not suddenly release the pedal and do not start moving with the gear shift more than 1/3 of the way towards «F» to avoid suddenly engaging drive which could cause the vehicle to tip and loss of control.

5.4.3 Braking

To brake:

1. first slow down the machine by reducing the engine speed;

2. push the pedal right down (☛4.2) to lower the speed even more until the machine stops.
3. Move the speed gear shift (☛4.4) to idle «N» to permit gradual motion.

5.4.4 Reverse

IMPORTANT

Reverse MUST be engaged only when the machine has stopped

1. When the machine has stopped, put it in reverse by moving the lever sideways to position «R» (☛4.4);
2. gradually release the pedal to engage the clutch and then begin moving in reverse.

5.4.5 Grass cutting

IMPORTANT

The blade is engaged by means of a clutch device.

To avoid damage or premature wear of the friction elements, strictly observe the following instructions.

To start cutting:

1. remove any foreign objects that could be hit by the blade (stones, branches, bones, wire etc.) and mark off the position of hidden elements that cannot be moved (roots, sprinklers etc.);
2. check that the grass-catcher (☛3.4) is fitted properly;
3. put the accelerator lever (☛4.8) into the «FAST» position;
4. bring the cutting deck to the highest position before engaging the blade (☛4.7);
5. only engage the blade without pausing in the intermediate positions when on the grass lawns. Avoid engaging the blade on stony ground or when the grass is very high.
6. start moving forwards onto the grass area very gradually and with particular caution, as already described;
7. on rough ground, adjust the cutting height to prevent the blade from knocking against uneven ground or foreign objects, damaging the blade and bracket;
8. Engage the most suitable gear in order to reach the desired forward speed (1st - 2nd gear) and adjust the cutting height (☛4.5) so that the quantity of grass to be removed is not too much that it jams the blade or clogs up the collector channel.

⚠ WARNING!

When cutting on sloping ground, the forward speed must be reduced to ensure safe conditions (☛ 1.2 - 5.5).

- Lower the speed whenever you note a reduction in engine speed, since a forward speed that is too fast compared to the amount of grass being cut will never mow the grass well.
- Disengage the blade and put the cutting deck in the highest position whenever you need to get past an obstacle or a hump.
- Use the 3rd gear only when moving the machine from one area to the other.

5.4.6 Unblocking the collector channel



WARNING!

This job must only be performed with the engine Turned off.

If the collector channel gets blocked (due to accumulated grass cuttings filling up the side discharge or an excessively high speed with relation to the quantity of grass cuttings), you need to:

1. stop forward movement immediately, disengage the blade and stop the engine;
2. remove the side discharge;
3. remove the accumulated cuttings, reaching them from the exit of the collector channel.

5.4.7 End of mowing

When you have finished mowing, disengage the blade, lower the engine speed and ride the machine with the cutting deck in the highest position.

5.4.8 End of work

Once you have finished mowing, stop the machine and engage the parking brake(➡4.3).



Electric start

1. shift the accelerator lever to «SLOW»;
2. switch off the engine by turning the key to «STOP»:



WARNING!

Always take out the ignition key before leaving the machine unattended!

IMPORTANT

To keep the battery charged, do not leave the key in the «ON» position when the engine is not running.



WARNING!

Always make sure that the accelerator level is in the «OFF» position before leaving the machine unattended!

5.4.9 cleaning the machine

After each mowing, clean the outside of the machine, remove residual grass and earth in side discharge.

Clean the plastic parts of the body with a damp sponge using water and detergent, taking care not to wet the engine, the electrical parts or the electronic card located under the dashboard.

IMPORTANT

Never use hose-nozzles or harsh detergents for cleaning the body and engine!



WARNING!

Do not let debris and dry remains of grass accumulate in upper part of the cutting deck in order to keep maximum machine efficiency and safety levels.

After each use, accurately clean the cutting deck to remove any grass remains or debris.

⚠ WARNING!

Wear eye protection and keep people or animals away from the surrounding area when cleaning the cutting deck.

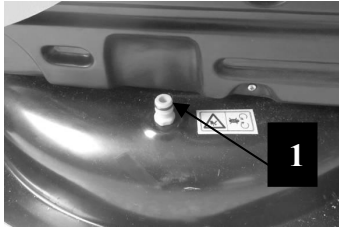

a) When washing the inside of the cutting deck and the collector channel, the machine must be on firm ground:

1. fit the grass-catcher;
2. connect a water hose to its pipe fitting (1), and run water through it;
3. sit at the operator's position;
4. lower the cutting deck completely;
5. start the engine and stay in neutral;
6. engage the blade and leave it to turn for a few minutes.

Take off the grass-catcher, empty and rinse it, then put it in a position where it can dry quickly.

b) To clean the upper part of the cutting deck:

- lower the cutting deck completely (position «1»);
- blow a jet of compressed air to remove any remains of grass.

5.4.10 Storage and inactivity for long periods

If the machine is likely to be unused for a long period (more than 1 month), follow the instructions in the engine manual.



Empty the fuel tank by removing the screw situated at the bottom of the fuel filter (1), and collects the fuel in a suitable container.

⚠ WARNING!

Carefully remove any dry grass cuttings which may have collected around the engine or silencer to prevent their catching fire the next time the machine is used!

Put the machine away in a dry, sheltered place and preferably covered with a cloth.

➡ Electric start

Disconnect the terminal of the battery .



IMPORTANT

The battery must be kept in a cool and dry place. Before a long storage period (more than 1 month), always charge the battery, and then recharge before using again (🔌)

6.2.3).

The next time the machine is used, check that there are no fuel leaks from the tubes or carburetor.

5.5 USING ON SLOPES

When mowing lawns on a slope, observe the maximum gradients already mentioned (**max 10° - 17%**) and move up and down but never across them. Take great care when changing direction that the highest wheels do not hit obstacles (such as stones, branches, roots, etc.) that may cause the machine to slide sideways, tip over or otherwise cause loss of control.

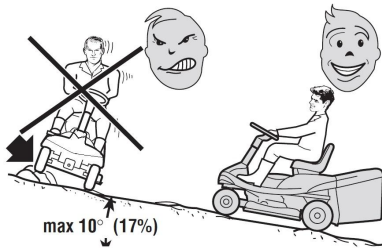

⚠ DANGER!

SLOW DOWN BEFORE CHANGING DIRECTION ON

SLOPES. Never use reverse to reduce speed going downhill: you may lose control of the machine, particularly on slippery surfaces. Never ride the machine on slopes in neutral or with the clutch out! Always engage a low gear and the parking brake before leaving the machine at a stopped and unattended.

⚠ WARNING!

Take care when beginning forward movement on sloping ground to prevent the risk of tipping up. Reduce the forward speed before going on a slope, particularly downhill.

5.6 TRANSPORTING

⚠ WARNING!

If the machine is transported on a truck or trailer, use ramps with suitable resistance, width and length. Load the machine with the engine switched off, without a driver and pushed by an adequate number of people. During transport, close the fuel stopcock (if fitted), lower the cutting deck, engage the parking brake and fasten the machine securely with ropes or chains to the hauling device.

5.7 ADVICE ON HOW TO OBTAIN A GOOD CUT

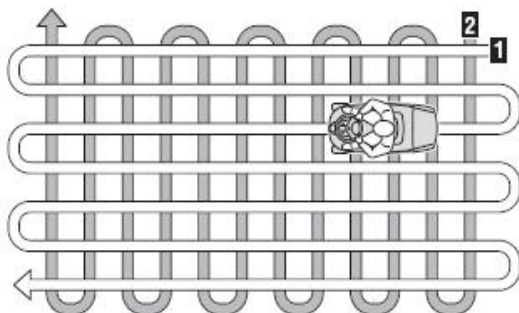

1. To keep a lawn green and soft with a good appearance, it should be cut regularly without damaging the grass.
2. It is always better to cut the grass when dry.
3. The blade must be in good condition and well sharpened so that the grass is cut straight without any ragged edge that leads to yellowing at the ends.
4. The engine must run at full speed, both to ensure a sharp cut of the grass and to get the necessary thrust to push the cuttings through the collector channel.
5. The frequency of mowing should be in relation to the rate of growth of the grass, which should not be left to grow too much between one cut and the next.
6. During hot and dry periods, the grass should be cut a little higher to prevent the ground from drying out.
7. If the grass is very tall, it should be cut twice in a twenty four hour period. The first time at maximum cutting height, possibly reducing the cutting width and the second cut at the height desired.
8. The appearance of the lawn will improve if you alternate the cutting in both directions.
9. If the collector channel tends to get blocked with grass, you should reduce the forward speed since this may be too high for the condition of the lawn. If the problem persists, the probable causes are either the badly sharpened blade or deformed wings.
10. Be very careful when mowing near bushes or kerbs since these could distort the horizontal position of the cutting deck, and damage its edge as well as the blade.

5.8 Use mulching function

1. Prepare the fitting parts.

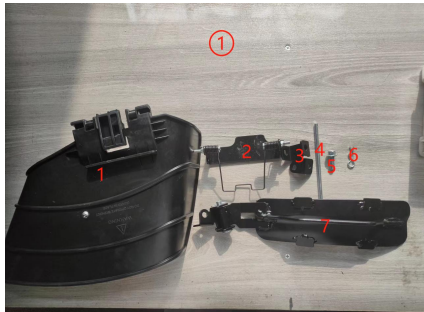

2. Fix the side row cover to the upper side of the chassis, and fix it with two screws through the nut.



3. Align the side shrouds with the mounting points of the circlip protrusions on the mount.



4. Insert the return snap ring into the side row shield.



5. The side row guard shaft enters from the left side of the side row guard cover, passes through the return circlip, and goes out from the right side of the side row guard cover.



6. The lock pin is inserted into the side row guard shaft, and the side row guard cover is installed.



7. Install the side row holder above the cutter wheel.



8. The side row hood cover welding assembly and the side row hood cover welding assembly fixing seat, the connection holes are aligned.



9. The rivets are inserted from above the fixing seat of the side hood cover welding assembly and pass through the side hood cover welding assembly.



10. Insert the locking pin under the rivet. Side row installation completed.



11. The installation is complete.



6. MAINTENANCE

6.1 SAFETY RECOMMENDATIONS

⚠ WARNING!

Disconnect the spark plug cap, remove the key (in the electric start models) or shift the accelerator lever to «OFF» (in the manual start models) and read the relevant instructions before starting any cleaning, maintenance or repairs. Wear suitable clothing and strong gloves for dismantling and refitting the blade and in all other hazardous situations for the hands.

⚠ WARNING!

Never use the machine with worn or damaged parts. Faulty or worn-out parts must always be replaced and not repaired. Only use original spare parts: The use or non-original and/or incorrectly fitted parts will compromise the safety of the machine, may cause accidents or personal injuries for which the Manufacturer is under no circumstance liable or responsible.

IMPORTANT

Never get rid of used oil, fuel or other pollutants in unauthorized places!

⚠ WARNING!

Any adjustments or maintenance operations not described in this manual must be carried out by your Dealer or a specialized Service Centre. Both have the necessary knowledge and equipment to ensure that the work is done correctly without affecting the safety of the machine. You must go to a specialized Service Centre or contact your Dealer of the following are malfunctioning:

- the brake;*
- the engagement and stop of the blade;*
- the drive engagement in forward and in reverse gears.*

6.2 ROUTINE MAINTENANCE

6.2.1 Engine

Follow all the instructions in the engine manual.

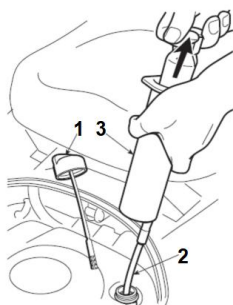

To drain the engine oil:

1. unscrew the topping up cap (1);
2. fit the pipe (2) onto the syringe (3) (on request) and insert it right into the hole;
3. using the syringe (3) (on request), suck up all the engine oil, bearing in mind that you need to repeat this operation a few times before all the oil is removed.

6.2.2 Transmission and gear unit

These are sealed single units which do not require maintenance. They are permanently lubricated and this lubricant does not need changing or topping up.

6.2.3 Battery

Electric start

To ensure long life to the battery it is essential to keep it carefully maintained.
The machine battery must always be charged:



- before using the machine for the first time after purchase;
- before leaving the machine for a prolonged period of disuse;
- before starting up the machine after a prolonged period of disuse.
- to ensure long life to the battery it is essential to keep it carefully maintained. Failure in following the procedure or in charging the battery could permanently damage the battery elements.
- A flat battery **must** be recharged as soon as possible.

IMPORTANT

*Recharging must be done using a battery charger at **constant voltage**. Other recharging systems can irreversibly damage the battery.*

The machine comes with a charging interface that can be connected to the interface provided by the battery charger.

IMPORTANT

This connector must only be used for connecting to the battery charger. For its use:

6.3 INTERVENTIONS ON THE MACHINE

6.3.1 Cutting deck alignment

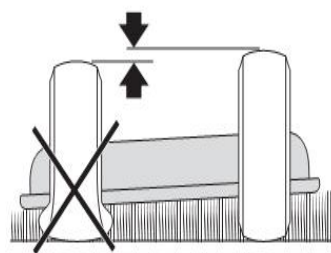

The cutting deck should be properly set to obtain a good cut.

If the cut is uneven, check the tire pressure.

If this is not sufficient to achieve an even cut, please contact your Dealer for the adjustment of the alignment of the cutting deck.

6.3.2 Replacing wheels

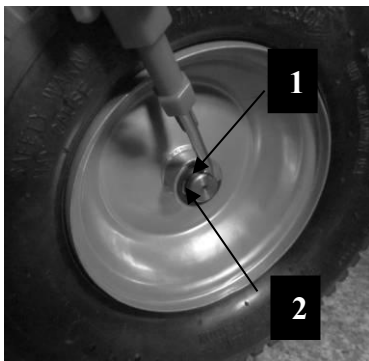

1. Place the machine on a flat surface and put blocks under a load-bearing part of the frame on the side of the wheel to be changed;
2. using a screwdriver, remove the snap ring (1) and the washer (2);
3. pull out the wheel
- 4.

IMPORTANT

Smear some waterproof grease on the axle and after refitting the wheel; carefully refit the washer (2) and the snap ring (1).

NOTE

If you have to replace one or both rear wheels, make sure that any differences in their external diameter does not exceed 8-10 mm; on the contrary, to prevent an uneven cut it will be necessary to adjust the alignment of the cutting deck.

6.3.3 Replacing and repairing tires

All puncture repairs or replacements will have to be carried out by a tire repair expert in accordance with the methods for the kind of tire used.

6.3.4 Replacing a fuse



Electric start

The electric system and the electronic card are protected by a fuse. When it blows the machine stops, so in this case:



1. remove the engine housing (1) using a hand;
2. replace the fuse (2) with another one with the same capacity;
3. remount the engine housing (1).
4. The fuse capacity is indicated on the fuse.

IMPORTANT

A blown fuse must always be replaced by one of the same type and ampere rating, and never with one of another rating.

If you cannot find out why the fuse has blown, consult a Licensed Service Centre.

6.3.5 Dismantling, replacing and remounting the blade



WARNING!

Always wear work gloves when handling the blade.

⚠ WARNING!

Damaged or bent blades must always be replaced; never try to repair them! ALWAYS USE MANUFACTURER'S GENUINE REPLACEMENT BLADES BEARING THE SYMBOL!

7. ENVIRONMENTAL PROTECTION

Environmental protection should be a priority of considerable importance when using the machine, for the benefit of both social coexistence and the environment in which we live.

- Try not to cause any disturbance to the surrounding area.
- Scrupulously comply with local regulations and provisions for the disposal of waste
- Scrupulously comply with local regulations and provisions for the disposal of oils, petrol, damaged parts or any elements which have a strong impact on the environment; this waste must not be disposed of as normal waste, it must be separated and taken to specified waste disposal centers where the material will be recycled.

At the time of decommissioning, do not pollute the environment.

8. TROUBLESHOOTING

PROBLEM	LIKELY CAUSE	SOLUTION
1. With the key on «START»	Electronic card blocked due to: <ul style="list-style-type: none"> - flat battery - fuse blown - bad earthing to the engine or the frame - earth connections of the micro switches disconnected - badly earthed starter motor - you are not ready for starting 	Turn the key to «STOP» and look for the cause the starter motor of the problem: does not run <ul style="list-style-type: none"> - recharge battery (☛6.2.3) - replace fuse (10A) (☛6.3.4) - check connections of black earth leads - check connections - check earth connections - check that the conditions allowing the start are met (☛5.2.a)
2. With the key on «START» the Starter motor runs but the engine does not start	<ul style="list-style-type: none"> - faulty fuel supply - faulty ignition 	<ul style="list-style-type: none"> - check the level in the tank - check the wiring of the fuel open command - check fuel filter - check that spark plug caps are firmly fitted - check that the electrodes are clean and have the correct gap - Check whether the spark plug cap is firmly installed

3. The engine stops	Electronic card blocked due to:	Turn the key to position«OFF» and look for the cause of the problem:
	- earth connections of the micros witches disconnected	- check connections
	- you are not ready for starting	- check that the conditions allowing the start are met
4. The engine does not start	- earth connections of the micros witches disconnected	- check connections
	- you are not ready for starting	- check that the conditions allowing the start are met
5. Difficult to start	-Carburetor failure	- Clean or replace the air filter
Unstable engine operation		-Flush carburetor float chamber -Drain the tank and refill the fuel -Check the fuel filter and replace it if necessary
6. Insufficient engine during cutting	-The forward speed is too fast relative to the cutting speed	-Reduce the forward speed or increase the cutting
7. When the blade rotation is started, the engine stops.	The engine speed is not high enough	-Increase the engine speed
8. Unusual vibrations while working	- blade unbalanced - blade loose - fixing bolts loose	- Contact your dealer - Contact your dealer - check and tighten all the fixing bolts of the engine and frame
9. Uncertain or ineffective braking	- the brake is not adjusted correctly	- Contact your Dealer



Do not take on complicated repair work if you don't have the necessary equipment or the technical knowledge. The warranty is automatically voided and the manufacturer is not held responsible if repairs are done badly.

9. ACCESSORIES ON REQUEST



1. BATTERY-CHARGER

Battery charger charges the battery when the machine is in storage.

Note: The Battery can be charged automatically if the motor is working.

2. Change Blade

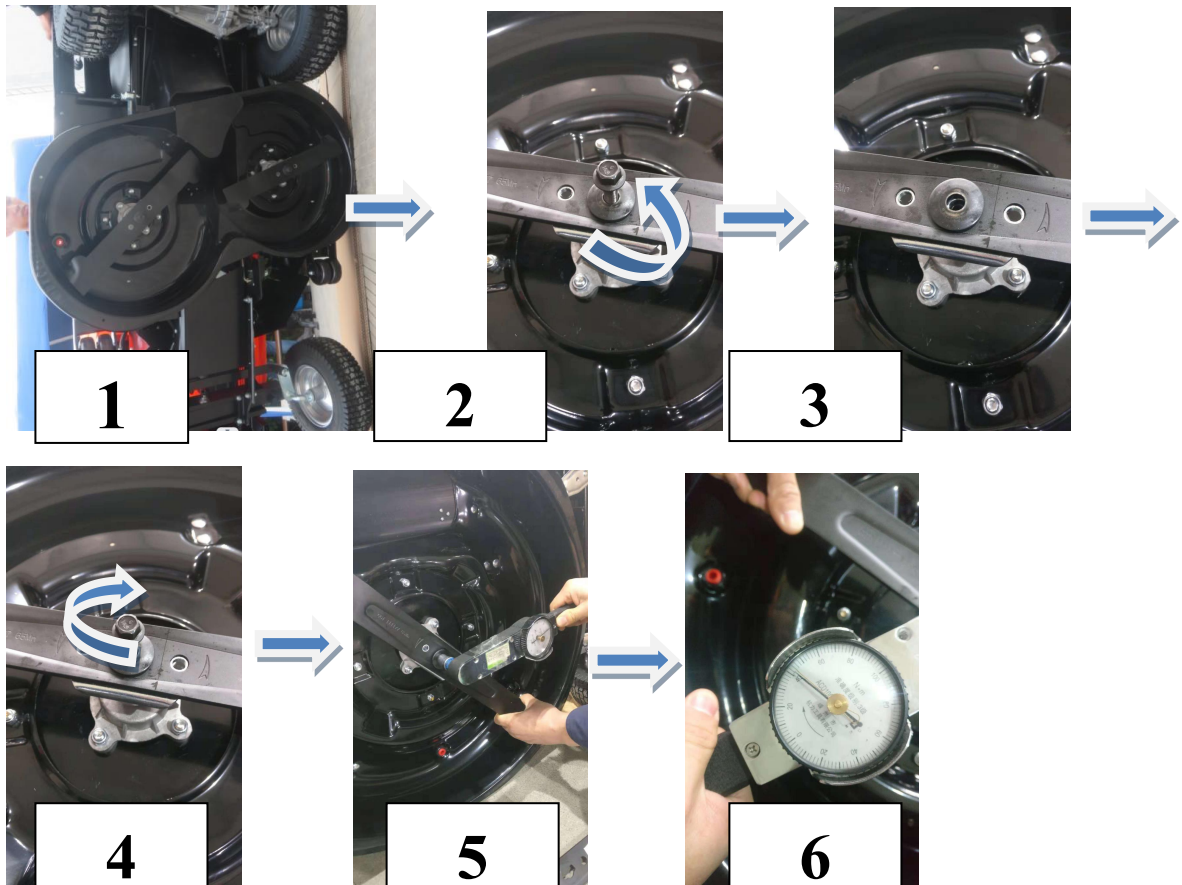

1. Make sure there is no machine oil and gasoline in the tank, side lay the machine as the picture above.

2. Loosen blade bolts and unscrew

3. Take the blade out and change the new one

4. Tighten bolt

5-6. Use the torque wrench to check if the torque is at least 40N.m.

10. SPECIFICATIONS

Model No.	FRT90EL
Sound pressure level, uncertainty	84.3 dB(A) K=3.0 dB
Sound power level, uncertainty	98.23 dB(A) K=0.93 dB
Guaranteed sound power level	100 dB(A)
Vibration, uncertainty	4.44 m/s ² K=1.5 m/s ²
Max. Engine power	6.5kW
Max. Engine Speed	2900/min
Engine displacement	352cm ³
Electrical system Battery	12V d.c. 12Ah
Fuel tank capacity	5000ml
Front wheel	13 inch
Rear wheel	15 inch
Net weight	150 kg
Cutting width	840mm
Cutting height	35-75 cm
Drives speed	1st: 1.95 km/h 2nd: 3.43 km/h 3rd: 5.15 km/h 4th: 5.69 km/h 5th : 8.58 km/h Reverse: 2.48 km/h
Packing dimension	169x100x73 cm

11. DECLARATION OF CONFORMITY



BUILDER SAS

32 rue Aristide Bergès - Z.I. du Casque - 31270 Cugnaux - France
Tel : +33 (0)5.34.502.502 Fax : +33 (0)5.34.502.503

declares that the machines:
PETROL LAWN TRACTOR

FRT90EL

Serial No.: 20221213152-20221213245

the people name holding the technical file: Mr. Olivier Patriarca

have been designed in compliance with the following standards:
EN-ISO 5395-1:2013+A1: 2018, EN-ISO 5395-3:2013+A1:2017+A2:2018
EN-ISO 14982: 2009

And in accordance with the following directives:
Machine Directive 2006/42/EC
EMC Directive 2014/30/EU
EMISSION Directive (EU)2016/1628
ROHS Directive 2011/65/EU +amendment 2015/863/EU
Noise Directive 2000/14/EC Annex VI & 2005/88/EC

Measured sound power level	98.23 dB(A) K=0.93 dB
Guarantee sound power level	100 dB(A)

Notify body:

TÜV Rheinland LGA Products GmbH - Tillystraße 2 - 90431
Notified by Zentralstelle der Länder für Sicherheitstechnik (ZLS).
Notified under No. **0197** to the EC Commission.

Cugnaux, 30/10/2022

Philippe MARIE / PDG

12. WARRANTY



WARRANTY

The manufacturer guarantees the product against defects in material and workmanship for a period of 2 years from the date of the original purchase. The warranty only applies if the product is for household use. The warranty does not cover breakdowns due to normal wear and tear.

The manufacturer agrees to replace parts identified as defective by the designated distributor. The manufacturer does not accept responsibility for the replacement of the machine, in whole or in part, and/or ensuing damage.

The warranty does not cover breakdowns due to:

- insufficient maintenance.
- abnormal assembly, adjustment or operations of the product.
- parts subject to normal wear and tear.

The warranty does not extend to:

- shipping and packaging costs.
- using the tool for a purpose other than that for which it was designed.
- the use and maintenance of the machine done in a manner not described in the user manual.

Due to our policy of continuous product improvement, we reserve the right to alter or change specifications without notice. Consequently, the product may be different from the information contained therein, but a modification will be undertaken without notice if it is recognized as an improvement of the preceding characteristic.

READ THE MANUAL CAREFULLY BEFORE USING THE MACHINE.

When ordering spare parts, please indicate the part number or code, you can find this in the spare parts list in this manual. Keep the purchase receipt; without it, the warranty is invalid. To help you with your product, we invite you to contact us by phone or via our website:

- **+33 (0)9.70.75.30.30**
- **<https://services.swap-europe.com/contact>**

You must create a "ticket" via the web platform.

- Register or create your account.
- Indicate the reference of the tool.
- Choose the subject of your request.
- Describe your problem.
- Attach these files: invoice or sales receipt, photo of the identification plate (serial number), photo of the part you need (for example: pins on the transformer plug which are broken).



13. PRODUCT FAILURE

WHAT TO DO IF MY MACHINE BREAKS DOWN?

If you bought your product in a store:

- a) Empty the fuel tank if your product has one.
- b) Make sure that your machine is complete with all accessories supplied, and clean! If this is not the case, the repairer will refuse the machine.

Go to the store with the complete machine and with the receipt or invoice.

If you bought your product on a website:

- a) Empty the fuel tank if your product has one.
- b) Make sure that your machine is complete with all accessories supplied, and clean! If this is not the case, the repairer will refuse the machine.
- c) Create a SWAP-Europe service ticket on the site: <https://services.swap-europe.com> When making the request on SWAP-Europe, you must attach the invoice and the photo of the nameplate (serial number).
- d) Contact the repair station to make sure it is available before dropping of the machine.

Go to the repair station with the complete machine packed, accompanied by the purchase invoice and the station support sheet downloadable after the service request is completed on the SWAP-Europe site

For machines with engine failure from manufacturers BRIGGS & STRATTON, HONDA and RATO, please refer to the following instructions.

Repairs will be done by approved engine manufacturers of these manufacturers, see their site:

- <http://www.briggsandstratton.com/eu/fr>
- <http://www.honda-engines-eu.com/fr/service-network-page;jsessionid=5EE8456CF39CD572AA2AEEDFD290CDAE>
- <https://www.rato-europe.com/it/service-network>

Please keep your original packaging to allow for after-sales service returns or pack your machine with a similar cardboard box of the same dimensions.

For any question concerning our after-sales service you can make a request on our website <https://services.swap-europe.com>

Our hotline remains available at +33 (9) 70 75 30 30.



14. WARRANTY EXCLUSIONS

THE WARRANTY DOES NOT COVER:

- Start-up and setting up of the product.
- Damage resulting from normal wear and tear of the product.
- Damage resulting from improper use of the product.
- Damage resulting from assembly or start-up not in accordance with the user manual.
- Breakdowns related to carburetion beyond 90 days and fouling of carburetors.
- Periodic and standard maintenance events.
- Actions of modification and dismantling that directly void the warranty.
- Products whose original authentication marking (brand, serial number) has been degraded, altered or withdrawn.
- Replacement of consumables.
- The use of non-original parts.
- Breakage of parts following impacts or projections.
- Accessories breakdowns.
- Defects and their consequences linked to any external cause.
- Loss of components and loss due to insufficient screwing.
- Cutting components and any damage related to the loosening of parts.
- Overload or overheating.
- Poor power supply quality: faulty voltage, voltage error, etc.
- Damages resulting from the deprivation of enjoyment of the product during the time necessary for repairs and more generally the costs related to the immobilization of the product.
- The costs of a second opinion established by a third party following an estimate by a SWAP-Europe repair station
- The use of a product which would show a defect or a breakage which was not the subject of an immediate report and/or repair with the services of SWAP-Europe.
- Deterioration linked to transport and storage*.
- Launchers beyond 90 days.
- Oil, petrol, grease.
- Damages related to the use of non-compliant fuels or lubricants.

* In accordance with transport legislation, damage related to transport must be declared to carriers within 48 hours maximum after observation by registered letter with acknowledgement of receipt.

This document is a supplement to your notice, a non-exhaustive list.

Attention: all orders must be checked in the presence of the delivery person. In case of refusal by the delivery person, it you must simply refuse the delivery and notify your refusal.

Reminder: the reserves do not exclude the notification by registered letter with acknowledgement within 72 hours.

Information:

Thermal devices must be wintered each season (service available on the SWAP-Europe site). Batteries must be charged before being stored.



BUILDER SAS

32, rue Aristide Bergès - ZI 31270 Cugnaux – France

Made in PRC 2022